



聆思科技
LISTENAI

CSK6011A AI SoC

Datasheet

CSDS-22003-021_V2.0

May 22, 2023

LISTENAI Proprietary and Confidential

Prepared and Provided Under NDA

LISTENAI Confidential

DISCLAIMER

Copyright © 2022-2023 Anhui LISTENAI Co., Ltd. All rights reserved.

The information presented in this document belongs to Anhui LISTENAI Co., Ltd. and/or its affiliates (LISTENAI). Without prior written permission of LISTENAI, no entity or individual shall copy, modify, or distribute part or all of the document in any way.

The information provided in this document is for reference only. LISTENAI does not give any representations or warranties, expressed or implied, as to the accuracy or completeness of such information. LISTENAI shall have no liability for any errors contained in this document.

LISTENAI reserves the right to make corrections, modifications, enhancements, improvements, and other changes to the content at any time without notice. LISTENAI reserves all the right for the final explanation.

LISTENAI, 聆思科技, and other LISTENAI icons are trademarks of Anhui LISTENAI Co., Ltd. All other trademarks and trade names mentioned in this document are the property of their respective holders.

LISTENAI Confidential

Update History

Version	Date	Update Description
V1.6	December 8, 2022	Updated TST pin descriptions. Corrected descriptive errors by changing VAD_AON to VDD_AON. Added PWM duty cycle error descriptions in Section 4.5, GPT.
V1.7	January 12, 2023	Updated Section 4, Functions.
V1.8	January 31, 2023	Added Section 5.2.11, Working Conditions.
V1.9	February 20, 2023	Updated Section 3.2, Pin Descriptions. Modified the recommended capacitance of VDD_IO and VMID to 2.2 μ F and 100 nF, respectively.
V2.0	May 22, 2023	Added Section 4.8, DMIC.

Table of Contents

1	Overview	1
2	Block Diagram	2
3	Pin Mapping and Descriptions	3
3.1	Pin Mapping	3
3.2	Pin Descriptions	3
4	Functions	6
4.1	Core	6
4.2	Memory	6
4.3	Clock Control	6
4.4	IO Port	7
4.5	GPT	7
4.6	SAR ADC	9
4.7	Audio Codec	10
4.8	DMIC	10
4.9	DVP	10
4.10	IWDG	11
4.11	UART	11
4.12	SPI	11
4.13	I2C	11
4.14	RTC	12
4.15	NPU	12
4.16	FCC RAM Controller	12
4.17	PDM2PCM	12
4.18	CRYPTO	12
4.19	eFuse Controller	13
4.20	True Random Number Generator	13
4.21	I2S Interface	13
4.22	USB1.1 Full Speed Device	13
4.23	SDIO	13
4.24	Power Management Unit	14
4.25	Touch	14
4.26	Audio ADC/DMIC/I2S	14
4.27	Boot Mode	14
4.28	Power Supply	15
5	Electrical Characteristics	16
5.1	Parameter Conditions	16
5.1.1	Minimum and Maximum Values	16
5.1.2	Typical Values	16
5.1.3	Loading Capacitor	16
5.1.4	Pin Input Voltage	16
5.2	Operation Conditions	16
5.2.1	Absolute Maximum Ratings	16

5.2.2	I/O Port Characteristics	17
5.2.3	IO AC Characteristics	18
5.2.4	nRESET Pin Characteristics	18
5.2.5	Supply Current Characteristics	18
5.2.6	Wake-up Time from the Sleep Mode	19
5.2.7	External Clock Source Characteristics	19
5.2.8	Internal Clock Source Characteristics	20
5.2.9	PLL Characteristics	20
5.2.10	EMC	20
5.2.11	Working Condition	20
6	Package Information	21
6.1	QFN64 (8*8 mm) Package Information	21
6.2	Thermal Characteristics	22
7	Reflow Profile	23
7.1	Reflow Diagram	23
7.2	SMT Reflow Conditions	24
8	Weight	25
9	Application Diagram	26

1 Overview

The CSK6 serial is a dual-core microcontroller embedded with an ARM STAR core and a HiFi4 core. The ARM Star core is designed for 32-bit microcontroller applications, offering high performance, low power, simple instruction set and addressing together with reduced code size compared with exiting solutions. The HiFi4 core is designed for audio coders and decoders such as MP3, AAC, and FLAC. The independent NPU is designed for neural network operation.

The CSK6 serial applies for smart home appliances.

The CSK6 serial can operate up to 300 MHz. Thus it can afford to support a variety of industrial control and applications that require high CPU performance. The CSK6 serial has a built-in 1-MB data SRAM.

The CSK6 serial supports many system-level peripheral functions, such as IO port, DVP, timer, watchdog timer, UART, SPI, I2C, DMA, PLL, USB1.1 (full speed), RTC, and SDIO.

2 Block Diagram

For the block diagram, see [Fig. 2.1](#).

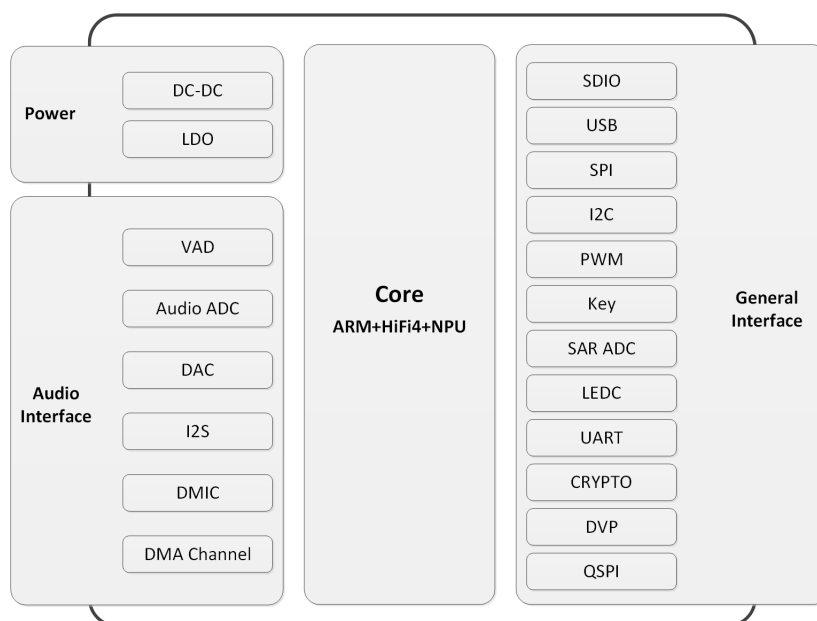

Fig. 2.1 Block Diagram

3 Pin Mapping and Descriptions

3.1 Pin Mapping

For the pin mapping diagram, see [Fig. 3.1](#).

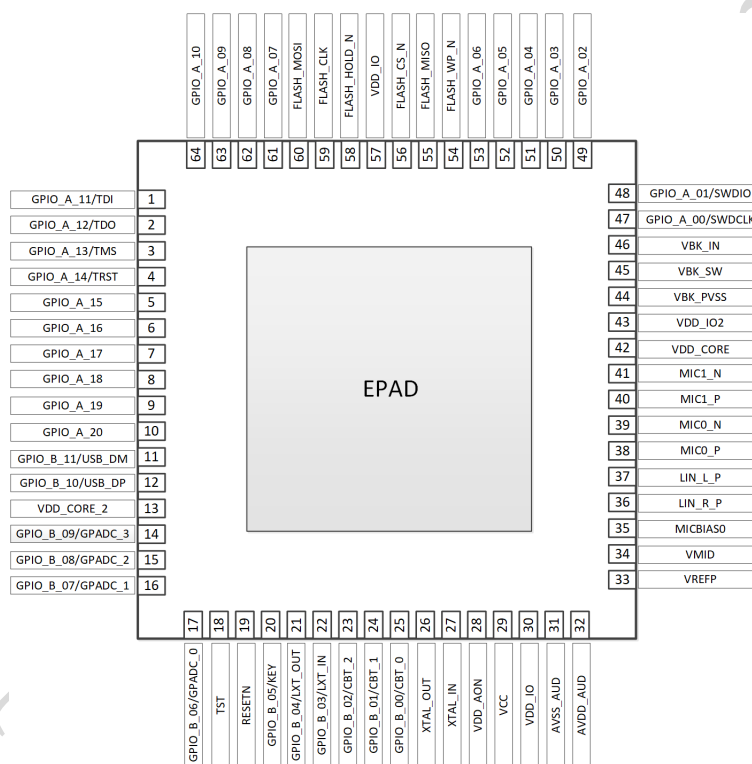

Fig. 3.1 Pin Mapping Diagram

3.2 Pin Descriptions

For pin descriptions, refer to [Table 3.1](#).

Table 3.1 Pin Descriptions

Pin Number	Pin Name	Description
1	GPIO_A_11	Multi-purpose digital I/O. Refer to 60XX_IOMUX.xlsx for details.
2	GPIO_A_12	Multi-purpose digital I/O. Refer to 60XX_IOMUX.xlsx for details.

continues on next page

Table 3.1 – continued from previous page

Pin Number	Pin Name	Description
3	GPIO_A_13	Multi-purpose digital I/O. Refer to 60XX_IOMUX.xlsx for details.
4	GPIO_A_14	Multi-purpose digital I/O. Refer to 60XX_IOMUX.xlsx for details.
5	GPIO_A_15	Multi-purpose digital I/O. It supports Boot ROM UART programming. Refer to 60XX_IOMUX.xlsx for details.
6	GPIO_A_16	Multi-purpose digital I/O. Refer to 60XX_IOMUX.xlsx for details.
7	GPIO_A_17	Multi-purpose digital I/O. Refer to 60XX_IOMUX.xlsx for details.
8	GPIO_A_18	Multi-purpose digital I/O. Refer to 60XX_IOMUX.xlsx for details.
9	GPIO_A_19	Multi-purpose digital I/O. Refer to 60XX_IOMUX.xlsx for details.
10	GPIO_A_20	Multi-purpose digital I/O. Refer to 60XX_IOMUX.xlsx for details.
11	GPIO_B_11/USB_DM	Multi-purpose digital I/O. Refer to 60XX_IOMUX.xlsx for details.
12	GPIO_B_10/USB_DP	Multi-purpose digital I/O. Refer to 60XX_IOMUX.xlsx for details.
13	VDD_CORE_2	Connect with VDD_CORE.
14	GPIO_B_09/GPADC_3	Multi-purpose digital I/O. Refer to 60XX_IOMUX.xlsx for details.
15	GPIO_B_08/GPADC_2	Multi-purpose digital I/O. Refer to 60XX_IOMUX.xlsx for details.
16	GPIO_B_07/GPADC_1	Multi-purpose digital I/O. Refer to 60XX_IOMUX.xlsx for details.
17	GPIO_B_06/GPADC_0	Multi-purpose digital I/O. Refer to 60XX_IOMUX.xlsx for details.
18	TST	Test pin. Default: pull-up. 0: test mode. 1: normal mode.
19	RESETN	Reset pin input. Default: pull-up.
20	GPIO_B_05/KEYSENSE	Multi-purpose digital I/O. Refer to 60XX_IOMUX.xlsx for details.
21	GPIO_B_04	Multi-purpose digital I/O. Refer to 60XX_IOMUX.xlsx for details.
22	GPIO_B_03	Multi-purpose digital I/O. Refer to 60XX_IOMUX.xlsx for details.
23	GPIO_B_02/CBT_2	Multi-purpose digital I/O. Refer to 60XX_IOMUX.xlsx for details.
24	GPIO_B_01/CBT_1	Multi-purpose digital I/O. Refer to 60XX_IOMUX.xlsx for details.
25	GPIO_B_00/CBT_0	Multi-purpose digital I/O. Refer to 60XX_IOMUX.xlsx for details.
26	XTAL_OUT	24-MHz crystal.
27	XTAL_IN	24-MHz crystal.
28	VDD_AON	Internal LDO output. Recommended capacitance: 1 μ F.
29	VCC	Power input: 2.7 V-5.5 V.
30	VDD_IO	Internal LDO output. Recommended capacitance: 2.2 μ F.
31	AVSS_AUD	GND

continues on next page

Table 3.1 – continued from previous page

Pin Number	Pin Name	Description
32	AVDD_AUD	Microphone bias output. Recommended capacitance: 2.2 μ F.
33	VREF	Audio codec reference input.
34	VMID	Internal LDO output. Recommended capacitance: 100 nF.
35	MICBIAS0	Microphone bias output. Recommended capacitance: 2.2 μ F.
36	LIN_R_P	Right channel differential outputs positive.
37	LIN_L_P	Left channel differential outputs positive.
38	MIC0_P	Microphone input positive.
39	MIC0_N	Microphone input negative.
40	MIC1_P	Microphone input positive.
41	MIC1_N	Microphone input negative.
42	VDD_CORE	Internal LDO output. Recommended capacitance: 4.7 μ F. Connect with VDD_CORE_2.
43	VDD_IO2	Internal power input. Recommended capacitance: 10 μ F.
44	VBK_PVSS	DC-DC GND.
45	VBK_SW	DC-DC switch out. Connected with a 3.3- μ H inductor.
46	VBK_IN	DC-DC input power: 2.7 V-5.5 V.
47	GPIO_A_00/SWDCLK	Multi-purpose digital I/O. Refer to 60XX_IOMUX.xlsx for details.
48	GPIO_A_01/SWDTMS	Multi-purpose digital I/O. Refer to 60XX_IOMUX.xlsx for details.
49	GPIO_A_02	Multi-purpose digital I/O. Refer to 60XX_IOMUX.xlsx for details.
50	GPIO_A_03	Multi-purpose digital I/O. Refer to 60XX_IOMUX.xlsx for details.
51	GPIO_A_04	Multi-purpose digital I/O. Refer to 60XX_IOMUX.xlsx for details.
52	GPIO_A_05	Multi-purpose digital I/O. Refer to 60XX_IOMUX.xlsx for details.
53	GPIO_A_06	Multi-purpose digital I/O. Refer to 60XX_IOMUX.xlsx for details.
54	FLASH_WP_N	Connect with an external QSPI flash.
55	FLASH_MISO	Connect with an external QSPI flash.
56	FLASH_CS_N	Connect with an external QSPI flash.
57	VDD_IO_1	Input power. Connect with VDD_IO.
58	FLASH_HOLD_N	Connect with an external QSPI flash.
59	FLASH_CLK	Connect with an external QSPI flash.
60	FLASH_MOSI	Connect with an external QSPI flash.
61	GPIO_A_07	Multi-purpose digital I/O. Refer to 60XX_IOMUX.xlsx for details.
62	GPIO_A_08	Multi-purpose digital I/O. Refer to 60XX_IOMUX.xlsx for details.
63	GPIO_A_09	Multi-purpose digital I/O. Refer to 60XX_IOMUX.xlsx for details.
64	GPIO_A_10	Multi-purpose digital I/O. Refer to 60XX_IOMUX.xlsx for details.
65	EPAD	Connect with GND.

Note: The pull-up resistor resistance is set to 80 K.

4 Functions

4.1 Core

- The ARM STAR and HiFi4 dual-core operates up to 300 MHz.
- Independent 128-GB NPU. Maximum speed: 300 MHz.
- Hardware multiplier and hardware divider.
- The embedded debug module supports the serial debug port (2-wire) and the JTAG debug port (4-wire).

4.2 Memory

- External NOR flash:
 - External flash through the QSPI.
 - The QSPI Supports 133 MHz maximumly.
- SRAM:
 - Totally 1088-KB SRAM shared by ARM and HiFi4 cores.
 - Dedicated 96-KB SRAM for the NPU block.
 - Maximum bandwidth: 600 MHz.
- PSRAM:
 - 8-MB PSRAM.
 - Maximum bandwidth: 400 MHz.

4.3 Clock Control

- Programmable system clock sources:
 - External 24-MHz high-speed crystal input to provide reference clock for the system.
 - External 32-KHz low-speed oscillator (optional).
 - Internal 32-KHz low-speed oscillator with calibration.
 - The PLL allows CPU operation up to 300 MHz with the system oscillator.

4.4 IO Port

- Up to 33 GPIO pins.
- GPIO configuration.
- Quasi-bidirectional (pull-up enabled).
- Pull-down.
- Push-pull (output).
- Input only (high-impedance).
- An I/O pin can be configured as an interrupt source through edge/level configuration.
- Flexible IO function selection.
- 5-V tolerance IO for GPIOA.

4.5 GPT

The GPT has eight independent channels and supports four LEDC outputs and eight PWM outputs. This multi-function timer provides the following four usage scenarios depending on the configuration of the channel mode register bit. The maximum output frequency of the PWM is 50 MHz.

- Timer mode
Support 8/16/32-bit timers.
- Input capture mode
The capture count mode is used to capture the number of input pulses and the capture time mode is used to capture pulse width.
- LEDC output mode
- PWM mode
PWM can be configured as central-aligned mode (see [Fig. 4.1](#)) and edge-aligned mode (see [Fig. 4.2](#)).

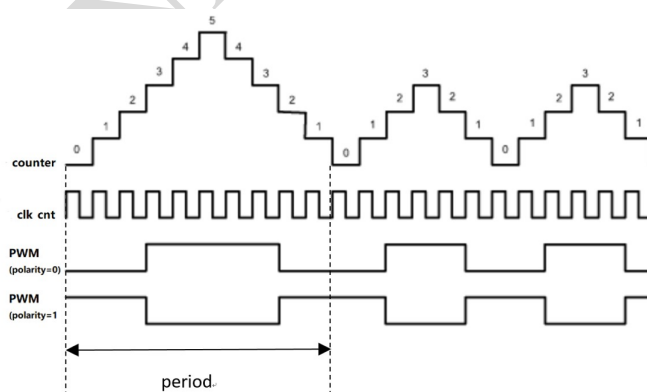

Fig. 4.1 Center-Aligned Mode

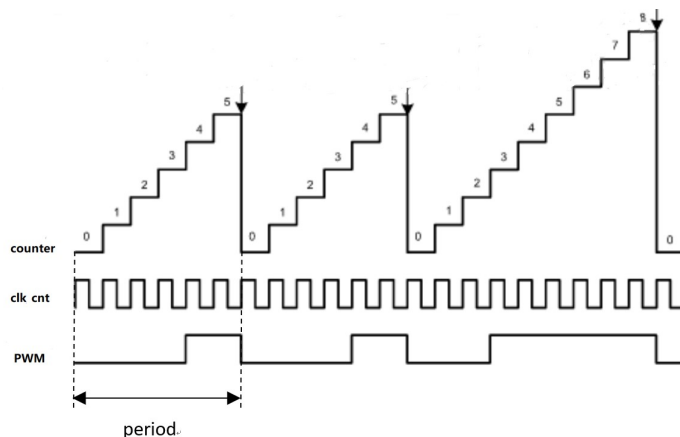

Fig. 4.2 Edge-Aligned Mode

- PWM output duty cycle 0% and 100%

If the duty cycle is set to 0% or 100%, the shadow register of the GPT module will not work. This will lead to pulse generation when the duty cycle is changed dynamically from zero to non-zero or from 100 to any other value.

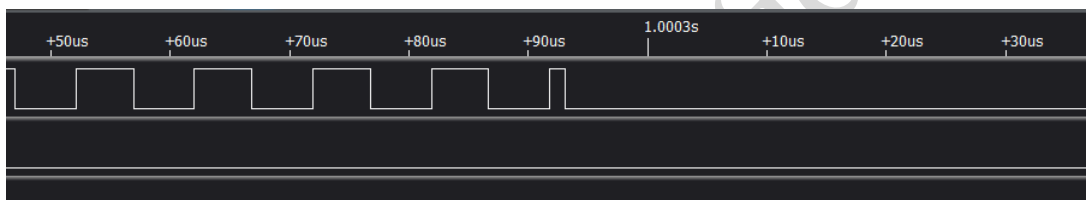

Fig. 4.3 Duty Change from 50% to 0

- PWM output duty cycle error

The PWM output duty cycle error depends on the frequency out and clock select values.

Take the PWM edge-aligned mode for example:

The actual high and low periods of PWM are *1 + high period* and *1 + low period* respectively.

Table 4.1 shows that different dividers will lead to different duty errors.

If the divider is set to 32, the real PWM clock is $100 \times 10^6 / 32$ and the total period PWM counter value is small (32).

If the divider is set to 8, the real PWM clock is $100 \times 10^6 / 8$ and the total period PWM counter value is big (125). this will greatly reduce duty errors.

If the target PWM frequency is 10 MHz and the divider is set to 1, the real PWM clock is $100 \times 10^6 / 1$, the total period PWM counter value is very small (10). This will greatly increase duty errors.

Table 4.1 High Duty Counter Value VS Duty

Clock Frequency Select (Hz)	100000000	100000000	100000000	100000000				
Divider	128	32	8	1				
Target PWM Frequency (Hz)	100000	100000	100000	10000000				
Total PWM Counter Value	5	29	123	8				
High Duty Counter Value VS Duty	Count Value	Duty (%)	Count Value	Duty (%)	Count Value	Duty (%)	Count Value	Duty (%)
	1	28	1	6	1	1	1	20
	2	42	2	9	2	2	2	30
	3	57	3	12	3	3	3	40

continues on next page

Table 4.1 – continued from previous page

	4	71	4	16	4	4	4	50
	-	-	5	19	5	4	5	60
	-	-	6	22	6	5	6	70
	-	-	7	25	7	6	7	80
	-	-	8	29	8	7	8	90
	-	-	9	32	9	8	-	-
	-	-	10	35	10	8	-	-
	-	-	11	38	11	9	-	-
	-	-	12	41	12	10	-	-
	-	-	13	45	13	11	-	-
	-	-	14	48	14	12	-	-
	-	-	15	51	15	12	-	-
	-	-	16	54	16	13	-	-
	-	-	17	58	17	14	-	-
	-	-	18	61	18	15	-	-
	-	-	19	64	19	16	-	-
	-	-	20	67	20	16	-	-
	-	-	21	70	21	17	-	-
	-	-	22	74	22	18	-	-
	-	-	23	77	23	19	-	-
	-	-	24	80	24	20	-	-
	-	-	25	83	25	20	-	-
	-	-	26	87	26	21	-	-
	-	-	27	90	27	22	-	-
	-	-	28	93	28	23	-	-

Note:

- Total PWM counter value = (Clock Frequency Select)/Divider/(Target PWM Frequency) - 2
- Duty (%) = (1 + count value)/(2 + Total PWM counter value)*100%

4.6 SAR ADC

- Up to four external channel inputs.
- Three internal channels (1/6 VDD, 1/8 VCC, Keysense).
- 12-bit resolution, up to 1 Msps, 24-MHz ADC clock.
- Configurable hardware ADC trigger sources.
- Configurable n-times ADC sampling.
- Dedicated ADC data FIFO for each ADC channel.
- Configurable ADC sampling duration.
- Configurable waiting time for the next round of A/D conversion.
- Switch on/off control.
- ADC trimming.
- ADC channel selection.
- External/internal VREF selection.
- Real voltage calculation:
 $Reg_{adc_value} = \text{ADC register value}$
 $\text{Voltage} = (Reg_{adc_value} - 2048)/2048 * 3.3$

4.7 Audio Codec

- 2-channel differential audio ADC input.
- 2-channel single-ended audio DAC output.
- Audio sample rates support 8 KHz to 96 KHz in the playback (DAC) path.
- Audio sample rates support 8 KHz, 16 KHz, 44.1 KHz, or 48 KHz in the record (ADC) path.
- DAC SNR about 95 dB, THD -85 dB ('A'-weighted @ 8-48 KS/s).
ADC SNR about 95 dB, THD -85 dB ('A'-weighted @ 8-48 KS/s).
- 32-bit APB control interface to ADC01 separately.
- 32-bit APB control interface to ADC23 and DAC01 separately.
- Programmable gain setting and soft mute control in the digital part.
- Programmable ALC loop/noise gate configuration in the ADC path.
Programmable ADC high-pass filter (wind noise reduction included).
The programmable ADC notch filter is selectable.
- ADC01 and ADC23 support two stereo digital microphones.
- Output gain/volume and mute control.

4.8 DMIC

- Sample rates support 8 KHz to 16 KHz
- Maximum support 4 channels

4.9 DVP

- Designed as an AHB master component that can access the memory without any DMAC service.
- Image frame completion notice and buffer switching.
- Support 4:2:2 output format in the line buffer for JPEG encoding.
- Data format: YUV422, YUV420, Raw Data.
- 8-bit to 12-bit configurable.
- Scalable image size (raw data specified):
 - 1280 × 720/60 FPS
 - 640 × 480/120 FPS
- Higher rates are possible with smaller images.

4.10 IWDG

- Clocked from an internal 32-KHz low-speed oscillator or from a 32768-Hz crystal if available.
- 32-bit free-running counter.
- Selectable timer-out interval.

4.11 UART

- Four UART interfaces (1 for debug).
- Three UARTs support hardware flow control (CTS/RTS) so that WiFi can be supported through UART interfaces.
- UART0 to UART2 support hardware handshake for DMA.
- Up to 3-Mb/s baudrate.
- Infrared supported.

4.12 SPI

- Three SPI interfaces.
- Maximumly 50 Mb/s for the master mode.
- Maximumly 25 Mb/s for the slave mode.
- An SPI with the QSPI function must be used for the embedded NOR flash or the external flash.
- Supports the master mode and the slave mode.
- Supports memory mapped access (read-only) through the AHB bus.
- Supports hardware handshake for DMA.
- Supports the dual I/O mode and the quad I/O mode (QSPI).

4.13 I2C

- Two I2C interfaces are available.
- Programmable to be a master or a slave device.
- Programmable clock/data timing.
- Supports the I2C-bus standard-mode (100 kb/s), fast-mode (400 kb/s), and fast-mode plus (1 Mb/s).
- Supports the hardware handshake for DMA.
- Supports the master-transmit, master-receive, slave-transmit, and slave-receive modes.
- Supports the multi-master mode.
- Supports 7-bit and 10-bit addressing.
- Supports general call addressing.
- Supports automatic clock stretch.

4.14 RTC

- Supports software compensation by setting the frequency compensation register.
- The frequency of the clock source (before the clock divider) for the counter is 32.768 KHz.
- Separate second, minute, hour, and day counters.
- Periodic interrupts: half-second, second, minute, hour, and day interrupts.
- Programmable alarm interrupt with specified second, minute, and hour numbers.

4.15 NPU

- Matrix and vector operation accelerator.
- AHB master interface for data read and write.
- APB interface for register configuration.
- Has interrupt signals.
- Support reverse order storage, overflow detection, and location shift.

4.16 FCC RAM Controller

- 200 MHz maximumly.
- Arbitrate the data access request from the CPU, HiFi4, NPU, and DMAC.
- Partition the NPU memory into several spaces.
- If the accesses from different agents are in different spaces, all of them can be done immediately.
- Flexible priority configuration: If the accesses from different agents are in the same space, the priority can be configured by users through the register.

4.17 PDM2PCM

- Support data conversion of PDM data from digital microphone to standard PCM data.
- CIC filter in the always-on domain and half-band filter and memory in the main power domain.

4.18 CRYPTO

- Support AES128 and SHA256 for secure communication.
- AHB master interface for data read and write.
- APB interface for register configuration.

4.19 eFuse Controller

- Read eFuse content after receiving reset release signal from the reset sequence control.
- Provide data to the crypto engine for encryption/decryption.
- Provide data to the QSPI encryption wrapper to protect the content of the NOR flash.

4.20 True Random Number Generator

- True random generator with mixed analog digital implementation to provide true random numbers.
- Register configuration and generated random numbers can be accessed through the APB bus.

4.21 I2S Interface

- Support extended microphone inputs.
- Support I2S audio inputs and outputs.
- Three independent I2S modules.
- An input or output signal can be TDM-extended.
- Register configuration and data operation through the APB bus.

4.22 USB1.1 Full Speed Device

- One set of 12-Mbps USB 1.1 FS device.
- On-chip USB Transceiver.
- Supports control, ISO in/out, bulk in/out, interrupt in/out transfers.
- Provides 8 programmable endpoints.
- Supports maximumly 1 KB for isochronous transfer and maximumly 64 bytes for bulk and interrupt transfer.
- Each endpoint is configurable.

4.23 SDIO

- Maximumly 25-MHz output clock
- Compliant with the SD host controller standard specification, version 3.0.
- Supports both DMA and non-DMA data transfer.
- Compliant with the SD physical layer specification, version 3.0.
- Supports UHS50/UHS104 SD cards.
- Supports configurable SD bus modes: 4-bit mode and 8-bit mode.
- Compliant with the SDIO card specification, version 3.0.
- Compliant with the mandatory part in the eMMC card specification, version 5.1.
- Supports configurable 1-bit/4-bit SD card bus and 1-bit/4-bit/8-bit EMMC card bus.
- Configurable CPRM function for security.

- Built-in generation and check for 7-bit and 16-bit CRC data.
- Card detection (insertion/removal).

4.24 Power Management Unit

- Supports the sleep mode to reduce power consumption.
- Supports wake-up through a RTC, timer, and key from IO.
- Supports wake-up through VAD.
- Supports system wakeup through touch.

4.25 Touch

- Supports touch point detection.
- Up to six touch pad inputs.

4.26 Audio ADC/DMIC/I2S

- The audio ADC shares the internal memory with the DMIC and the I2S. For the restrictions on combination use, refer to [Table 4.2](#).

Table 4.2 Restrictions on Combination Use

Occupied ADC/DAC	Available I2S	Available DMIC	Description
ADC01 only, no DAC	I2S1, I2S2	DMIC2, DMIC3	
ADC23 only, no DAC	I2S0, I2S1 or I2S2	DMIC0, DMIC1	I2S1 or I2S2 (either-or)
ADC01+ADC23, no DAC	I2S1 or I2S2	None	I2S1 or I2S2 (either-or)
ADC01 only, with DAC	I2S0, I2S2 (in)	DMIC2, DMIC3	I2S2 (in)
ADC23 only, with DAC	I2S0, I2S1 or I2S2 (in)	DMIC0, DMIC1	I2S1 or I2S2 (in) (either-or)
ADC01+ADC23, with DAC	I2S1 or I2S2 (in)	None	I2S1 or I2S2 (in) (either-or)

4.27 Boot Mode

For descriptions of the GPIOB0 and GPIOB1 boot modes, refer to [Table 4.3](#).

Table 4.3 Boot Mode

GPIOB0	GPIOB1	Mode Description
1	1	NOR flash boot
1	0	UART
0	1	Reserved
0	0	DSP boot only

Note: GPIOA15 (RXD) and GPIOA18 (TXD) are configured as the UART function in the UART boot mode.

4.28 Power Supply

- Single power 2.7 V to 5.5 V.

LISTENAI Confidential

5 Electrical Characteristics

5.1 Parameter Conditions

Unless otherwise specified, all voltages are referred to as V_{SS} .

5.1.1 Minimum and Maximum Values

Unless otherwise specified the minimum and maximum values are guaranteed in the worst conditions of ambient temperature, supply voltage and frequencies during test in production on 100% of the devices with an ambient temperature at 25 °C and the maximum temperature in the range.

Data based on characterization results, design simulation and/or technology characteristics are indicated in the table footnotes and are not tested in production. Based on characterization, the minimum and maximum values are based on sample tests and represent the mean value plus or minus three times the standard deviation ($\text{mean} \pm 3\sigma$).

5.1.2 Typical Values

Unless otherwise specified, typical data is based on $T_A = 25\text{ °C}$, $V_{CCIN} = 5\text{ V}$ (voltage range: $2.7\text{ V} \leq V_{CCIN} \leq 5\text{ V}$). They are given only as design guidelines and are not tested.

5.1.3 Loading Capacitor

The loading capacitor used for pin parameter measurement is 10 pf.

5.1.4 Pin Input Voltage

The input voltage measurement on a pin of the device is through the current source device.

5.2 Operation Conditions

5.2.1 Absolute Maximum Ratings

For information about voltage characteristics, refer to [Table 5.1](#).

Table 5.1 Voltage Characteristics

Symbol	Ratings	Min	Max	Unit
$V_{CCIN}-V_{SS}$	External supply voltage	-0.3	5.5	V
V_{IL}	Low-level input voltage on signal pins	-0.3	0.8	V
V_{IH}	High-level input voltage on signal pins (port A)	2	5.5	V
V_{IH}	High-level input voltage on signal pins (port B)	2	3.6	V
V_{OL}	Low-level output voltage on signal pins		0.4	V
V_{OH}	High-level output voltage on signal pins	2.4		V

5.2.2 I/O Port Characteristics

For information about I/O Static characteristics, refer to [Table 5.2](#).

Table 5.2 I/O Static Characteristics

Symbol	Parameter	Conditions	Min	Typ	Max	Unit
V_{IL}	Standard IO low-level input voltage	$2.7\text{ V} \leq V_{CCIN} \leq 5.5\text{ V}$ $T_A = 25\text{ }^\circ\text{C}$	- 0.3		0.8	V
V_{IH}	Standard IO high-level input voltage (port A)	$2.7\text{ V} \leq V_{CCIN} \leq 5.5\text{ V}$ $T_A = 25\text{ }^\circ\text{C}$	2		5.5	V
V_{IH}	Standard IO high-level input voltage (port B)	$2.7\text{ V} \leq V_{CCIN} \leq 5.5\text{ V}$ $T_A = 25\text{ }^\circ\text{C}$	2		3.6	V
V_{hys}	Standard IO Schmitt trigger voltage hysteresis	$2.7\text{ V} \leq V_{CCIN} \leq 5.5\text{ V}$ $T_A = 25\text{ }^\circ\text{C}$		220		mV
V_{OL}	Low-level output voltage	$2.7\text{ V} \leq V_{CCIN} \leq 5.5\text{ V}$ $T_A = 25\text{ }^\circ\text{C}$			0.4	V
V_{OH}	High-level output voltage	$2.7\text{ V} \leq V_{CCIN} \leq 5.5\text{ V}$ $T_A = 25\text{ }^\circ\text{C}$	2.4			V
I_{OL}	Low-level output current	$2.7\text{ V} \leq V_{CCIN} \leq 5.5\text{ V}$ $T_A = 25\text{ }^\circ\text{C}$		15		mA
I_{OH}	High-level output current	$2.7\text{ V} \leq V_{CCIN} \leq 5.5\text{ V}$ $T_A = 25\text{ }^\circ\text{C}$		22		mA
I_{Ikg}	Input leakage current	$2.7\text{ V} \leq V_{CCIN} \leq 5.5\text{ V}$ $T_A = 25\text{ }^\circ\text{C}$		1		μA
R_{PU}	Pull-up equivalent resistor		74 k	80 k	158 k	Ω
R_{PD}	Pull-down equivalent resistor		62 k	75 k	203 k	Ω
C_{IO}	I/O pin capacitance			5		pF

Note: Only port A is a 5-V tolerance IO and the input voltage can be 5.5 V maximumly.

5.2.3 IO AC Characteristics

For information about I/O AC characteristics, refer to [Table 5.3](#).

Table 5.3 IO AC Characteristics

Symbol	Parameter	Conditions	Min	Typ	Max	Unit
$F_{\max(\text{io})\text{out}}$	Maximum frequency	$2.7\text{ V} \leq V_{\text{CCIN}} \leq 5.5\text{ V}$ $T_{\text{A}} = 25\text{ }^{\circ}\text{C}$ $C_{\text{L}} = 10\text{ pf}$		100		MHz
$T_{\text{f}(\text{IO})\text{out}}$	Fall time and rise time	$2.7\text{ V} \leq V_{\text{CCIN}} \leq 5.5\text{ V}$ $T_{\text{A}} = 25\text{ }^{\circ}\text{C}$ $C_{\text{L}} = 10\text{ pf}$		2.5		ns
		$2.7\text{ V} \leq V_{\text{CCIN}} \leq 5.5\text{ V}$ $T_{\text{A}} = 25\text{ }^{\circ}\text{C}$ $C_{\text{L}} = 10\text{ pf}$		2.5		ns

5.2.4 nRESET Pin Characteristics

For information about nRESET pin characteristics, refer to [Table 5.4](#).

Table 5.4 nRESET Pin Characteristics

Symbol	Parameter	Conditions	Min	Typ	Max	Unit
R_{PU}	Pull-up equivalent resistor	$2.7\text{ V} \leq V_{\text{CCIN}} \leq 5.5\text{ V}$ $T_{\text{A}} = 25\text{ }^{\circ}\text{C}$		80 k		Ω
$T_{(\text{nRESET})}$	nRESET input pulse	$2.7\text{ V} \leq V_{\text{CCIN}} \leq 5.5\text{ V}$ $T_{\text{A}} = 25\text{ }^{\circ}\text{C}$ $C_{\text{L}} = 10\text{ pf}$		1		ms

5.2.5 Supply Current Characteristics

For information about supply current characteristics, refer to [Table 5.5](#).

Table 5.5 Supply Current Characteristics

Symbol	Parameter	Conditions	f_{sysclk} (MHz)	Typical	Unit
I_{DD}	Supply current in RUN mode	$V_{\text{CCIN}} = 5 \text{ V}$, external 24-MHz crystal $T_{\text{A}} = 25 \text{ }^{\circ}\text{C}$, PLL ON, AP ON, CP ON, NPU ON PSRAM off, NOR flash cached	100	20	mA
	Supply current in VAD& DEEPSLEEP mode	$T_{\text{A}} = 25 \text{ }^{\circ}\text{C}$, deep sleep mode entered, VAD mode enabled with 1 audio ADC on (analog mic not included)	24	1.8	mA
	Supply current in DEEP-SLEEP mode	$T_{\text{A}} = 25 \text{ }^{\circ}\text{C}$, deep sleep mode entered	24	700	μA

5.2.6 Wake-up Time from the Sleep Mode

For information about wake-up time from the sleep mode, refer to [Table 5.6](#).

Table 5.6 Wakeup Time from Sleep Modes

Symbol	Parameter	Conditions	Typical	Unit
t_{WUSLEEP}	Wakeup from sleep	External pin wake-up (ROM boot not included)	< 2	ms

5.2.7 External Clock Source Characteristics

For information about external clock source characteristics, refer to [Table 5.7](#).

Table 5.7 External Clock Source Characteristics

Symbol	Parameter	Conditions	Min	Typ	Max	Unit
f_{osc}	External clock source frequency			24		MHz
V_{OSCH}	OSC in input pin high level voltage			3.3		V
V_{OSCL}	OSC in input pin low level voltage			0		V
$C_{\text{IN(OSC)}}$	OSC in input capacitance			5		pF
$D_{\text{ucy(OSC)}}$	Duty cycle		45		55	%
I_{L}	OSC IN input leakage current			430		μA

5.2.8 Internal Clock Source Characteristics

For information about internal clock source characteristics, refer to [Table 5.8](#).

Table 5.8 Internal Clock Source Characteristics

Symbol	Parameter	Conditions	Min	Typ	Max	Unit
f_{LSI}	Frequency	$2.7\text{ V} \leq V_{CCIN} \leq 5.5\text{ V}$ $T_A = 25\text{ }^\circ\text{C}$		32		KHz
$t_{su(LSI)}$	LSI oscillator start-up time	$2.7\text{ V} \leq V_{CCIN} \leq 5.5\text{ V}$ $T_A = 25\text{ }^\circ\text{C}$		5		s
$I_{DD(LSI)}$	LSI oscillator power consumption	$2.7\text{ V} \leq V_{CCIN} \leq 5.5\text{ V}$ $T_A = 25\text{ }^\circ\text{C}$			1	μA

5.2.9 PLL Characteristics

For information about PLL characteristics, refer to [Table 5.9](#).

Table 5.9 PLL Characteristics

Symbol	Parameter	Conditions	Min	Typ	Max	Unit
f_{PLL_IN}	PLL input clock			24		MHz
f_{PLL_OUT}	PLL output clock			300		MHz
Jitter	Cycle-to cycle jitter			10		ps

5.2.10 EMC

For information about Electromagnetic Compatibility (EMC), refer to [Table 5.10](#).

Table 5.10 EMC

Symbol	Ratings	Conditions	Class	Maximum Value	Unit
VESD (HBM)	Electrostatic discharge voltage (human body model)	$T_A = 25\text{ }^\circ\text{C}$	2	2000	V
VESD (CDM)	Electrostatic discharge voltage (charge device model)	$T_A = 25\text{ }^\circ\text{C}$		1000	V

5.2.11 Working Condition

The working temperature ranges from $-40\text{ }^\circ\text{C}$ to $+85\text{ }^\circ\text{C}$.

6 Package Information

6.1 QFN64 (8*8 mm) Package Information

For the package information, see *Fig. 6.1*, *Fig. 6.2*, and *Fig. 6.3*.

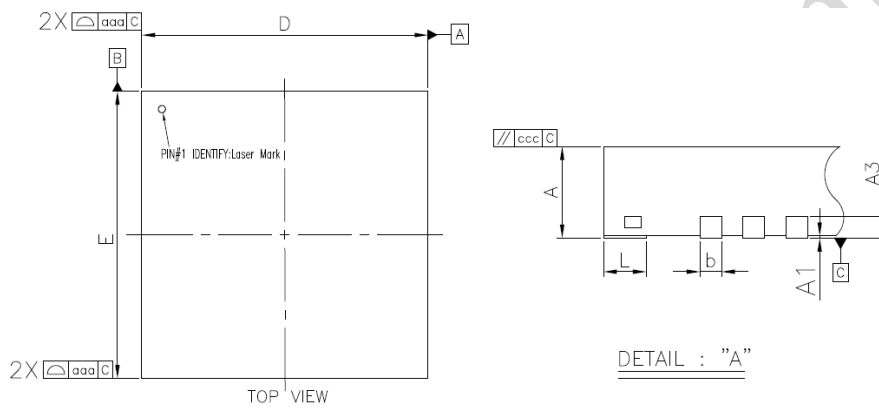

Fig. 6.1 Top View

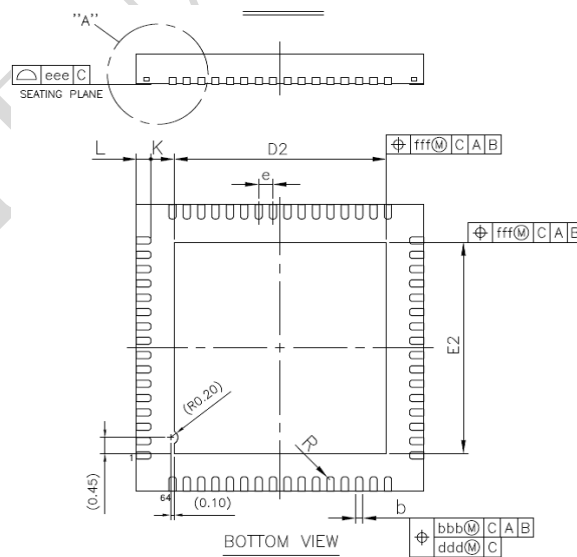

Fig. 6.2 Bottom View

Symbol	Dimension in mm			Dimension in inch		
	MIN	NOM	MAX	MIN	NOM	MAX
A	0.80	0.85	0.90	0.031	0.033	0.035
A1	0.00	0.02	0.05	0.000	0.001	0.002
A3	0.20 REF			0.008 REF		
b	0.15	0.20	0.25	0.006	0.008	0.010
D	7.90	8.00	8.10	0.311	0.315	0.319
E	7.90	8.00	8.10	0.311	0.315	0.319
D2	5.80	5.90	6.00	0.228	0.232	0.236
E2	5.80	5.90	6.00	0.228	0.232	0.236
e	0.40 BSC			0.016 BSC		
L	0.30	0.40	0.50	0.012	0.016	0.020
K	0.20	---	---	0.008	---	---
R	0.08	---	0.13	0.003	---	0.005
aaa	0.10			0.004		
bbb	0.07			0.003		
ccc	0.10			0.004		
ddd	0.05			0.002		
eee	0.08			0.003		
fff	0.10			0.004		

NOTE:

1. CONTROLLING DIMENSION : MILLIMETER
2. REFERENCE DOCUMENT: JEDEC MO-220.

Fig. 6.3 Symbol Dimension

6.2 Thermal Characteristics

The maximum chip junction temperature (T_{Jmax}) in degrees Celsius can be calculated through the following equation:

$$T_{Jmax} = T_{Amax} + (P_{Dmax} * \theta_{JA})$$

where:

- T_{Amax} is the maximum ambient temperature in °C.
- θ_{JA} is the package junction-to-ambient thermal resistance in °C/W.
- P_{Dmax} is the sum of P_{INTmax} and $P_{I/Omax}$ ($P_{Dmax} = P_{INTmax} + P_{I/Omax}$).
- P_{INTmax} is the product of I_{DD} and V_{DD} in Watts. This is the maximum chip internal power.

$P_{I/Omax}$ represents the maximum power dissipation on output pins and can be calculated through the following equation:

$$P_{I/Omax} = \sum (V_{OL} * I_{OL}) + ((V_{DD} - V_{OH}) * I_{OH})$$

The actual V_{OL}/I_{OL} and V_{OH}/I_{OH} of the I/Os at low and high levels in the application are taken into account.

Table 6.1 Package Thermal Characteristics

Symbol	Parameter	Value	Unit
θ_{JA}	Junction-to-ambient thermal resistance QFN64 – 8*8 mm	28	°C/W
T_{STG}	Storage temperature range	-65 to +150	°C
T_J	Maximum junction temperature	125	°C

7 Reflow Profile

7.1 Reflow Diagram

For the reflow diagram, see *Fig. 7.1*.

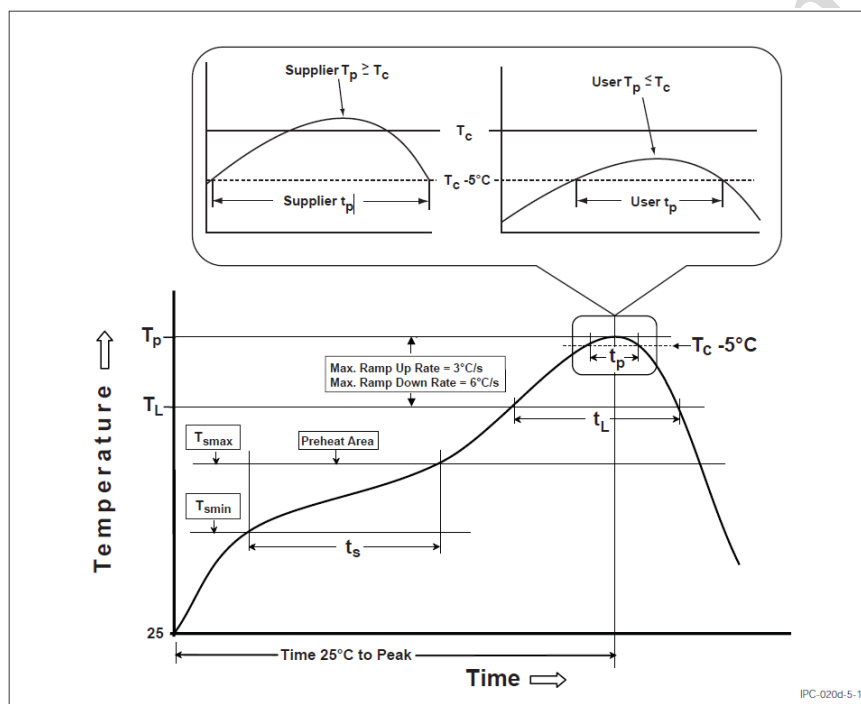

Fig. 7.1 Reflow Diagram

7.2 SMT Reflow Conditions

Table 7.1 Reflow Parameter Descriptions

Parameter	Requirement
N2 purge reflow usage	Yes
O2 ppm level	< 1500 ppm
Temperature Min (T_{smin})	150 °C
Temperature Max (T_{smax})	200 °C
Time (t_s) from (T_{smin} to T_{smax})	60-120 seconds
Ramp-up rate (T_L to T_P)	3 °C/second maximumly
Liquidous temperature (T_L)	217 °C
Time(t_L) maintained above T_L	60-150 seconds
Peak package body temperature (T_P)	T_P must not exceed the Classification temp (T_C) in table below
Time(t_p) within 5 °C of the specified classification temperature (T_C)	30 seconds maximumly
Ramp-down rate (T_P to T_L)	6 °C/second maximumly
Time 25 °C to peak temperature	8 minutes maximumly

Table 7.2 Corresponding Relationship among Thickness, Volume, and Temperature

Package Thickness	Volume mm ³ < 350	Volume mm ³ 350-2000	Volume mm ³ > 2000
< 1.6 mm	260 °C	260 °C	260 °C
1.6 mm-2.5 mm	260 °C	250 °C	245 °C
> 2.5 mm	250 °C	245 °C	245 °C

8 Weight

The SoC weighs 200 mg.

LISTENAI Confidential

9 Application Diagram

For the application diagram, see [Fig. 9.1](#).

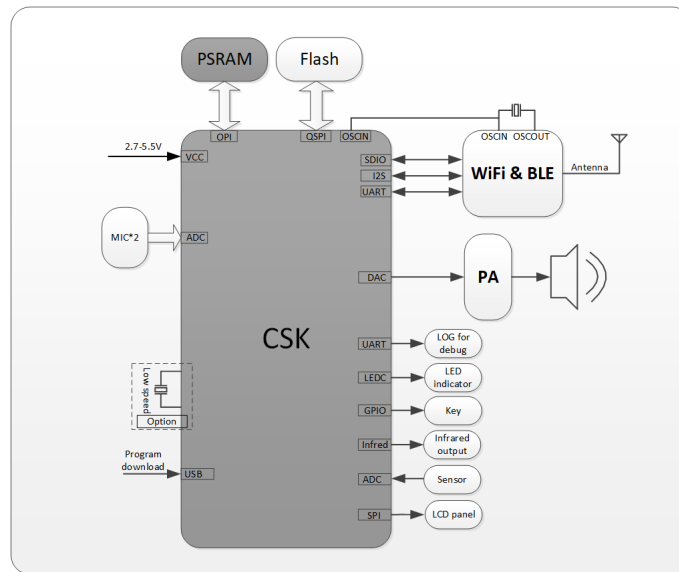

Fig. 9.1 Application Diagram